



(12) **United States Design Patent**
King et al.

(10) **Patent No.:** **US D762,040 S**
(45) **Date of Patent:** **** Jul. 19, 2016**

(54) **MULTISPACE PARKING PAY STATION**

G07F 19/205; G07F 19/21; G07F 19/00;
G07F 7/04; G07F 5/00; G07F 1/00; E05G
7/001; E05G 1/006; A63H 33/00; A63G
33/005

(71) Applicant: **IPS Group Inc.**, San Diego, CA (US)

(72) Inventors: **David William King**, Rancho Santa Fe,
CA (US); **Murray David Kirby**
Hunter, Birchgrove (AU); **David**
Andrew Jones, Beecroft (AU); **Choor**
Hong Tan, Wentworth Point (AU);
Michael W MacCollum, Poway, CA
(US); **Ron Lawrence**, San Diego, CA
(US); **Anthony Babaran**, San Diego,
CA (US)

See application file for complete search history.

(56) **References Cited**

U.S. PATENT DOCUMENTS

D278,689 S 5/1985 Jupe
4,754,126 A * 6/1988 Caldwell G07D 11/0096
235/379

(Continued)

OTHER PUBLICATIONS

Co-pending U.S. Appl. No. 29/548,020, filed Dec. 9, 2015.

(Continued)

Primary Examiner — Elizabeth J Oswecki

(74) *Attorney, Agent, or Firm* — Wilson, Sonsini, Goodrich
& Rosati

(73) Assignee: **IPS GROUP INC.**, San Diego, CA (US)

(**) Term: **15 Years**

(21) Appl. No.: **29/545,062**

(22) Filed: **Nov. 9, 2015**

Related U.S. Application Data

(63) Continuation-in-part of application No. 29/477,324,
filed on Dec. 20, 2013, now Pat. No. Des. 746,015.

(51) **LOC (10) Cl.** **99-00**

(52) **U.S. Cl.**

USPC **D99/28**

(58) **Field of Classification Search**

USPC D99/28, 34, 35, 36, 43, 99;
D14/300-302, 305, 307, 900-902;
D18/3.1-3.3, 4.1-4.6, 12.1-12.3;
D21/324, 325, 329, 369, 370; 101/66;
109/1 R, 1 V, 2, 23, 24.1, 25, 58, 58.5,
109/66; 446/8-13; 705/16, 17, 18, 42, 43,
705/44, 45; 235/51, 379, 380, 382
CPC . G06Q 20/10; G06Q 20/108; G06Q 20/1085;
G06Q 20/18; G07D 1/00; G07D 1/02; G07D
1/04; G07D 1/06; G07D 11/00; G07D 9/002;
G07D 9/04; G07F 19/20; G07F 19/201;
G07F 19/202; G07F 19/203; G07F 19/204;

(57) **CLAIM**

The ornamental design for a multispace parking pay station,
as shown and described.

DESCRIPTION

FIG. 1 is a top front perspective view of a multispace parking
pay station, showing my new design;
FIG. 2 is a front elevational view thereof;
FIG. 3 is a rear elevational view thereof;
FIG. 4 is a left side elevational view thereof;
FIG. 5 is a right side elevational view thereof; and,
FIG. 6 is a top plan view thereof.

The broken lines shown in the drawings represent portions of
the multispace parking pay station that form no part of the
claimed design.

All surfaces not shown form no part of the claimed design.

1 Claim, 4 Drawing Sheets

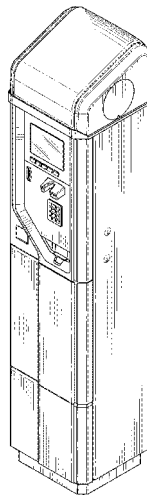

(56)

References Cited

U.S. PATENT DOCUMENTS

5,065,156 A 11/1991 Bernier
 D336,860 S 6/1993 Clough
 D342,209 S 12/1993 Clough
 D360,734 S 7/1995 Hall
 D375,607 S 11/1996 Hall
 D396,655 S 8/1998 Anderson
 5,915,246 A * 6/1999 Patterson G06Q 20/1085
 705/14.4
 D412,289 S 7/1999 Winwood
 6,029,888 A * 2/2000 Harvey G06K 7/0034
 235/379
 D431,788 S 10/2000 Tuxen et al.
 D437,468 S * 2/2001 Fukutake D99/28
 6,230,868 B1 5/2001 Tuxen et al.
 6,275,169 B1 8/2001 Krygler et al.
 D448,910 S 10/2001 Kit
 D450,253 S 11/2001 Marguet
 D454,421 S 3/2002 Jeon
 D460,005 S 7/2002 Jacquet
 6,505,774 B1 1/2003 Fulcher et al.
 D472,362 S 3/2003 Zerman et al.
 6,527,172 B1 * 3/2003 Lewis G07F 19/205
 235/375
 D481,516 S 10/2003 Magee
 D485,417 S 1/2004 Magee
 D488,280 S 4/2004 Zerman
 D492,080 S 6/2004 Magee
 D492,081 S 6/2004 Magee
 D494,730 S 8/2004 Magee
 D497,814 S 11/2004 Odinotski et al.
 D505,240 S 5/2005 Swaine et al.
 D505,765 S * 5/2005 Swaine D99/28
 D510,751 S 10/2005 Magee et al.
 7,004,385 B1 2/2006 Douglass
 7,019,670 B2 3/2006 Bahar
 7,028,888 B2 4/2006 Laskowski
 7,040,534 B2 5/2006 Turocy et al.
 D530,880 S * 10/2006 Magee D99/28
 7,131,576 B2 * 11/2006 Utz G07F 19/20
 235/379
 D538,505 S 3/2007 Kang
 7,222,782 B2 5/2007 Lute, Jr. et al.
 7,284,692 B1 10/2007 Douglass
 D570,920 S 6/2008 Choi
 7,419,091 B1 9/2008 Scanlon
 D579,795 S 11/2008 Martinez et al.
 7,445,144 B2 11/2008 Schlabach et al.
 D582,125 S 12/2008 Kang et al.
 D592,825 S * 5/2009 Kang D99/28
 7,533,802 B1 5/2009 McGinley et al.
 D596,373 S * 7/2009 Kang D99/28
 D596,374 S 7/2009 Kang
 7,624,919 B2 12/2009 Meek et al.
 7,699,224 B2 4/2010 Mole
 D615,274 S * 5/2010 Kim D99/28
 D625,305 S 10/2010 Bleck
 D629,585 S * 12/2010 Bleck D14/307
 D632,740 S 2/2011 Adeline
 D645,223 S 9/2011 Bleck
 D652,872 S 1/2012 Mougin et al.
 D653,014 S 1/2012 Rohan
 D653,420 S 1/2012 Rohan
 D653,421 S 1/2012 Rohan
 D653,424 S 1/2012 Rohan
 D672,525 S 12/2012 Lee et al.
 D674,985 S 1/2013 Lee
 D677,035 S 2/2013 Lee
 D677,714 S * 3/2013 Helgesson D14/900

D680,156 S 4/2013 Hernandez et al.
 D681,717 S 5/2013 Helgesson et al.
 D682,504 S * 5/2013 Lee D14/900
 D684,745 S 6/2013 Reuter
 D691,165 S 10/2013 Attoma
 D693,983 S 11/2013 Budde et al.
 D696,484 S 12/2013 Lee
 D696,485 S 12/2013 Lee
 D702,913 S 4/2014 Budde
 D702,914 S 4/2014 Budde
 D716,515 S 10/2014 Cha
 D722,740 S 2/2015 Budde
 D724,290 S 3/2015 Cha et al.
 D724,811 S 3/2015 Reitinger
 D724,812 S 3/2015 Cha et al.
 D728,190 S 4/2015 Sheley
 D732,263 S * 6/2015 Budde D99/28
 D735,437 S 7/2015 Randall
 D735,438 S 7/2015 Randall
 D735,439 S 7/2015 Randall
 D735,440 S 7/2015 Randall
 D735,963 S 8/2015 Randall
 D735,964 S 8/2015 Randall
 D735,965 S 8/2015 Randall
 D739,637 S 9/2015 Randall
 D741,040 S * 10/2015 Budde D99/28
 D742,090 S 10/2015 Randall
 D746,015 S * 12/2015 King D99/28
 D748,364 S * 1/2016 King D99/28
 D748,888 S * 2/2016 King D99/28
 D749,290 S * 2/2016 Pollmann D99/28
 2004/0016796 A1 1/2004 Hanna et al.
 2004/0243526 A1 12/2004 Krygler et al.
 2004/0262379 A1 12/2004 Gomes
 2005/0029340 A1 2/2005 Ferraro
 2006/0152385 A1 7/2006 Mandy
 2007/0046651 A1 3/2007 Sinclair et al.
 2007/0276724 A1 11/2007 Catt
 2008/0257965 A1 10/2008 Klein et al.
 2008/0265019 A1 10/2008 Artino et al.
 2008/0296365 A1 12/2008 Schliebe
 2009/0057398 A1 3/2009 Douglass et al.
 2010/0161489 A1 6/2010 Goodall et al.
 2010/0187300 A1 7/2010 Ramachandran et al.
 2010/0241564 A1 9/2010 Miller et al.
 2010/0243729 A1 9/2010 Russell et al.
 2011/0133613 A1 6/2011 Descamps et al.
 2012/0286036 A1 11/2012 Jones et al.

OTHER PUBLICATIONS

Co-pending U.S. Appl. No. 29/548,022, filed Dec. 9, 2015.
 Co-pending U.S. Appl. No. 29/548,023, filed Dec. 9, 2015.
 Co-pending U.S. Appl. No. 29/548,024, filed Dec. 9, 2015.
 Co-pending U.S. Appl. No. 29/477,176, filed Dec. 19, 2013.
 Co-pending U.S. Appl. No. 29/477,201, filed Dec. 19, 2013.
 Co-pending U.S. Appl. No. 29/477,204, filed Dec. 19, 2013.
 Co-pending U.S. Appl. No. 29/477,321, filed Dec. 20, 2013.
 Co-pending U.S. Appl. No. 29/477,324, filed Dec. 20, 2013.
 Co-pending U.S. Appl. No. 29/477,329, filed Dec. 20, 2013.
 Co-pending U.S. Appl. No. 29/545,046, filed Nov. 9, 2015.
 U.S. Appl. No. 29/477,176 Office Action dated May 4, 2015.
 U.S. Appl. No. 29/477,200 Office Action dated Apr. 9, 2015.
 U.S. Appl. No. 29/477,201 Office Action dated Apr. 9, 2015.
 U.S. Appl. No. 29/477,204 Office Action dated Apr. 9, 2015.
 U.S. Appl. No. 29/477,321 Office Action dated May 15, 2015.
 U.S. Appl. No. 29/477,324 Office Action dated Apr. 23, 2015.
 U.S. Appl. No. 29/477,329 Office Action dated May 22, 2015.
 U.S. Appl. No. 29/477,402 Office Action dated Apr. 9, 2015.

* cited by examiner

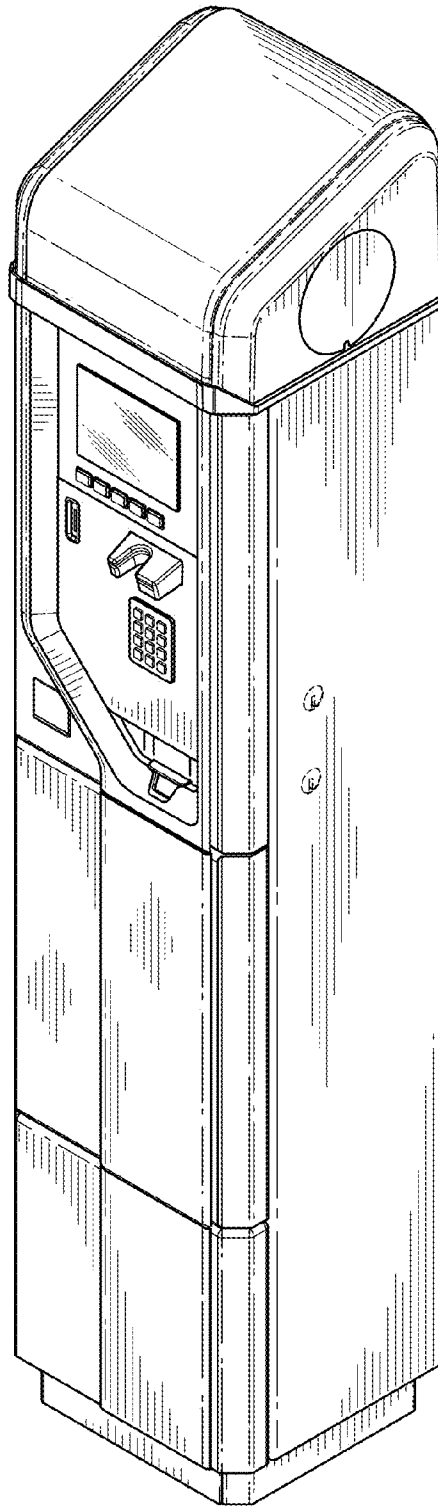

FIG. 1

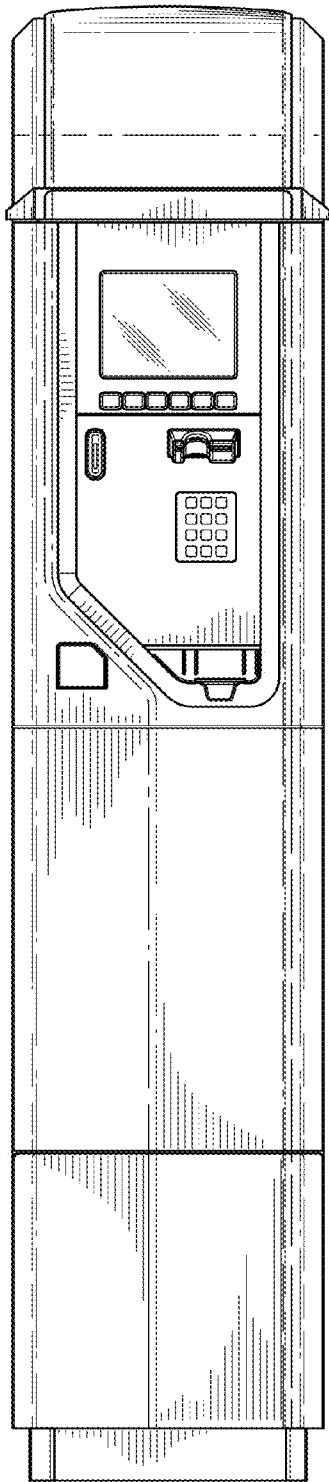

FIG. 2

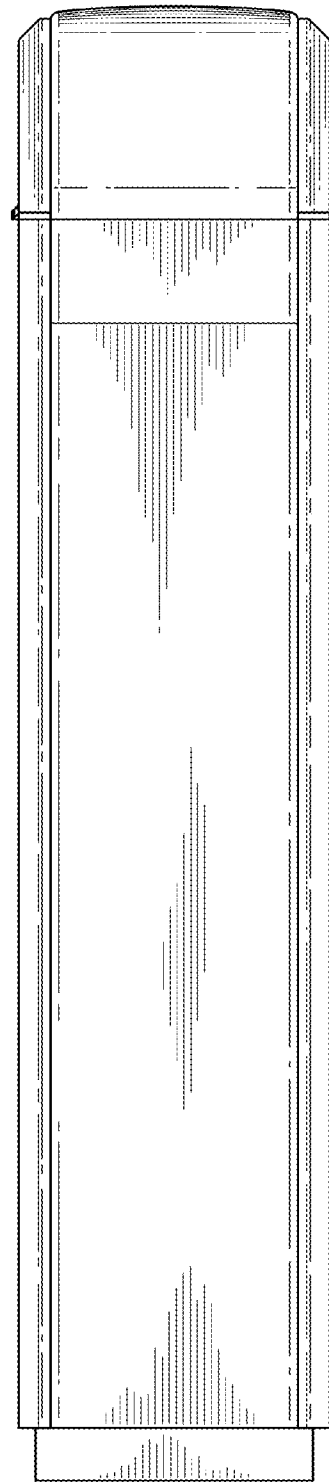

FIG. 3

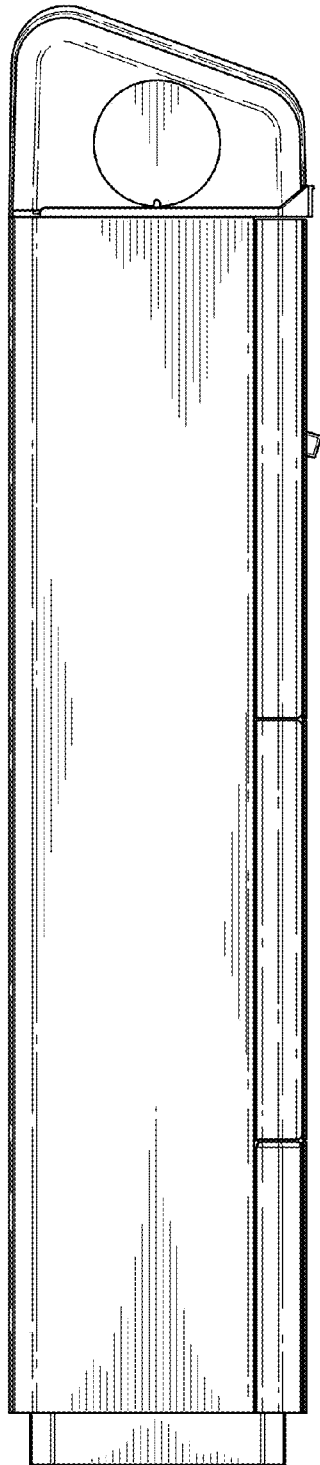

FIG. 4

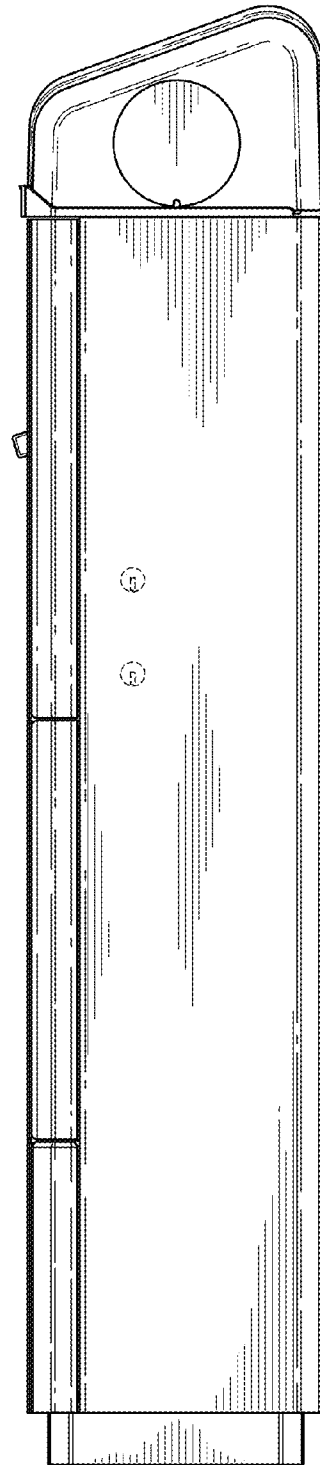

FIG. 5

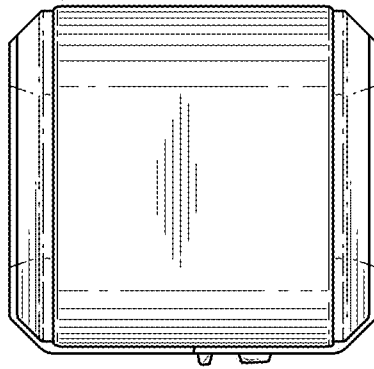

FIG. 6