



Office de la Propriété
Intellectuelle
du Canada
Un organisme
d'Industrie Canada

Canadian
Intellectual Property
Office
An agency of
Industry Canada

Registration Number:
Date of Registration:

171650
2017-11-30

MULTISPACE PARKING PAY STATION

Applicant(s) as Filed: **IPS GROUP, INC.**

Description:

The Design consists of the features of shape, configuration, and ornament of the MULTISPACE PARKING PAY STATION as shown in solid lines in the drawings.

1 / 3

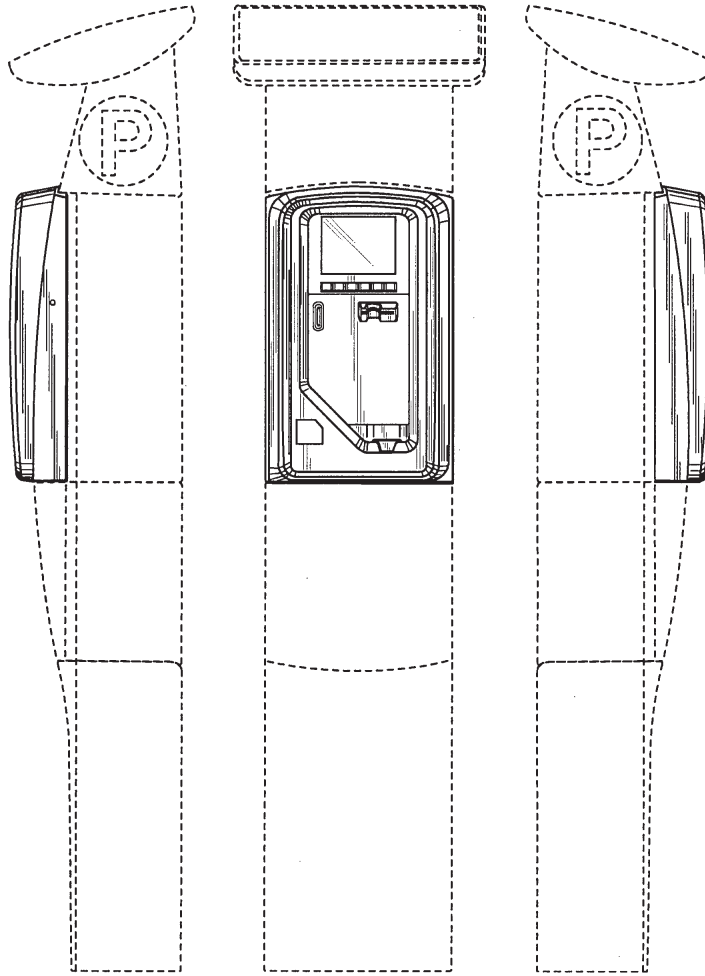

FIG. 2

FIG. 1

FIG. 3

Details

Third-Party Information Liability Disclaimer

Some of the information on this Web page has been provided by external sources. The Government of Canada is not responsible for the accuracy, reliability or currency of the information supplied by external sources. Users wishing to rely upon this information should consult directly with the source of the information. Content provided by external sources is not subject to official languages, privacy and accessibility requirements.

National Application/Registration : 171650

Date of Registration :

2017-11-30

Made available on :

2017-11-30

Status :

Registered

Title or finished article: MULTISPACE PARKING PAY STATION

Canadian Classification:

10-03-OTHER TIME-MEASURING INSTRUMENTS

20-01-AUTOMATIC VENDING MACHINES

Other Classes Searched:

N/A

Description:

The Design consists of the features of shape, configuration, and ornament of the MULTISPACE PARKING PAY STATION as shown in solid lines in the drawings. Portions shown in stippled lines do not form part of the design. Drawings of the Design are included, in which: Figure 1 is a front elevational view of a MULTISPACE PARKING PAY STATION; Figure 2 is a right side elevational view thereof; Figure 3 is a left side elevational view thereof; Figure 4 is a rear elevational view thereof; Figure 5 is a top plan view thereof; Figure 6 is a bottom plan view thereof; and Figure 7 is a top front perspective view thereof.

Statement:

N/A

Interested Parties

Applicant(s) as Filed:

IPS GROUP INC.

Registered Proprietor(s):

IPS GROUP INC.
7737 KENAMAR COURT
SAN DIEGO, 92121
CALIFORNIA, UNITED STATES OF AMERICA

Proprietor(s):

IPS GROUP INC.
7737 KENAMAR COURT
SAN DIEGO, 92121
CALIFORNIA, UNITED STATES OF AMERICA

Client Reference Number:

81801277 (83472-53)

Representative for Service:

SMART & BIGGAR LLP
2300-1055 WEST GEORGIA BOX 11115
VANCOUVER, V6E 3P3
BRITISH COLUMBIA, CANADA

Agent:

SMART & BIGGAR LLP
2300-1055 WEST GEORGIA BOX 11115
VANCOUVER, V6E 3P3
BRITISH COLUMBIA, CANADA

Registration Expiry date (Subject to payment of a maintenance fee): 10 years

Maintenance Fee Paid:

No

Filing Date:

2016-11-16

Correction(s):

No

Priority Claim(s):

Third-Party Information Liability Disclaimer

1 / 3

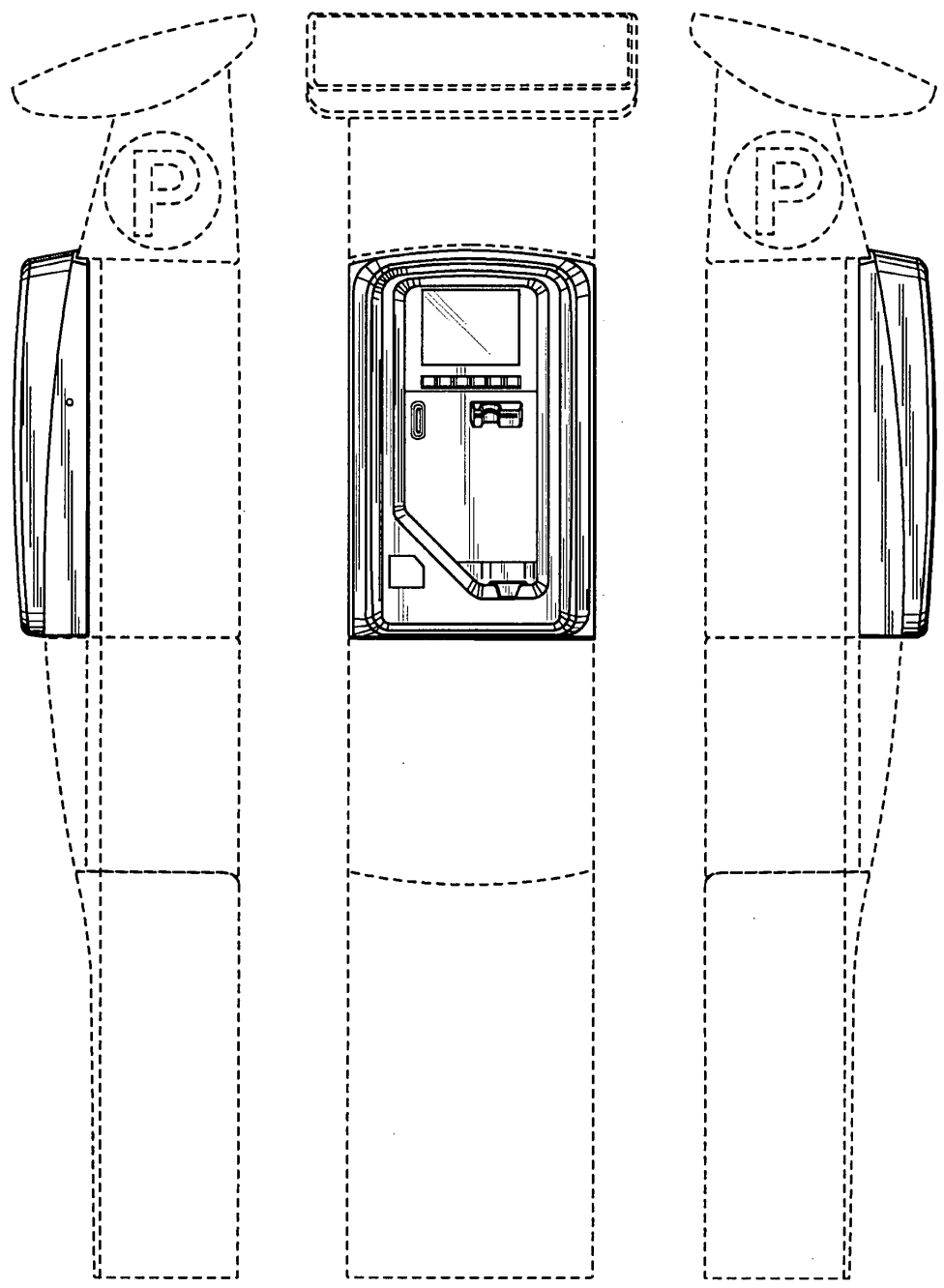

FIG. 2

FIG. 1

FIG. 3

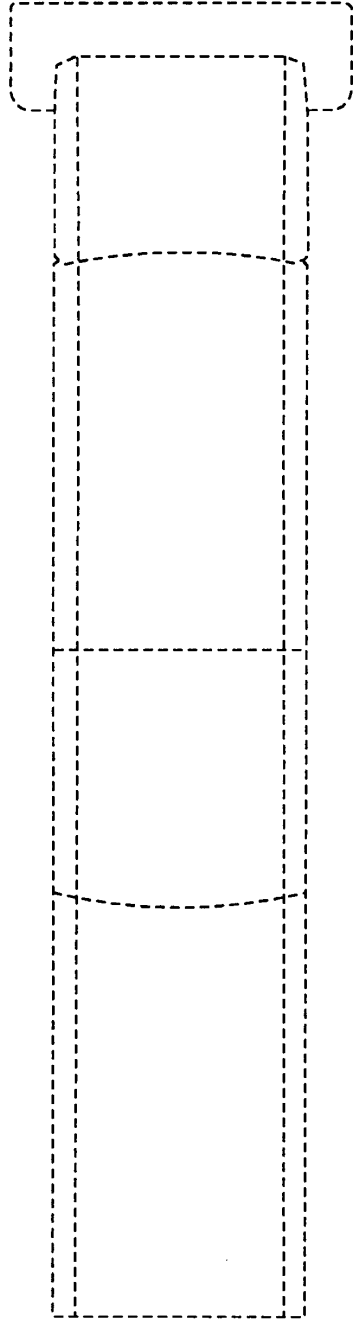

FIG. 4



FIG. 5

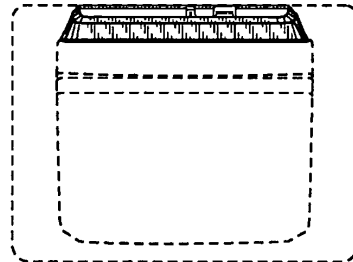

FIG. 6

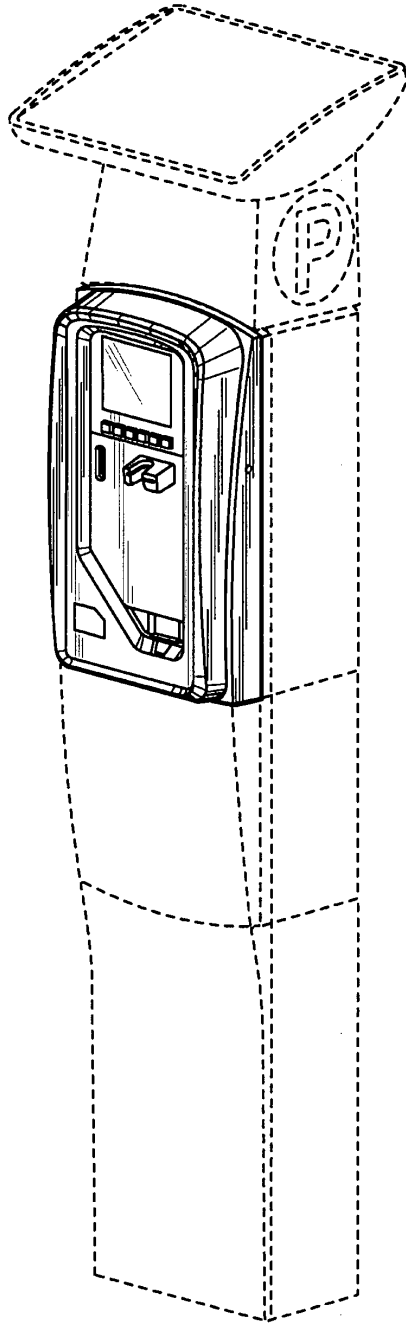

FIG. 7